

**iCOM**

**INSTRUCTION MANUAL**

VHF MARINE TRANSCEIVER  
(FULL DUPLEX CAPABILITY)

**IC-M500D**

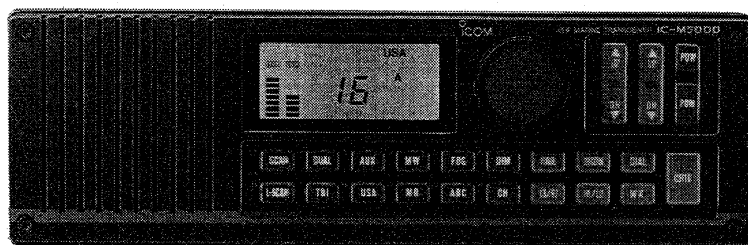

**Icom Inc.**

# FOREWORD

Thank you for choosing the **IC-M500D VHF MARINE TRANSCEIVER**. Icom uses the most advanced, state-of-the-art engineering concepts and the latest technology when designing its communication products.

This attractively styled new **IC-M500D** has the following advanced features:

- Floating ground design
- Full duplex capability
- Strong splash-resistant, dust-tight case with molded frame design
- 25W of high transmission output power
- Icom's new TRI WATCH function
- All marine channels pre-programmed
- 48 user-programmable memory channels
- HAILER and INTERCOM operations available
- 25W of hailer output power
- Variety of scan functions

To fully appreciate the capabilities of your new **IC-M500D**, please read this instruction manual thoroughly. Also, visit your nearest authorized Icom Dealer or Service Center if you have questions relating to the operation of the transceiver.

# UNPACKING

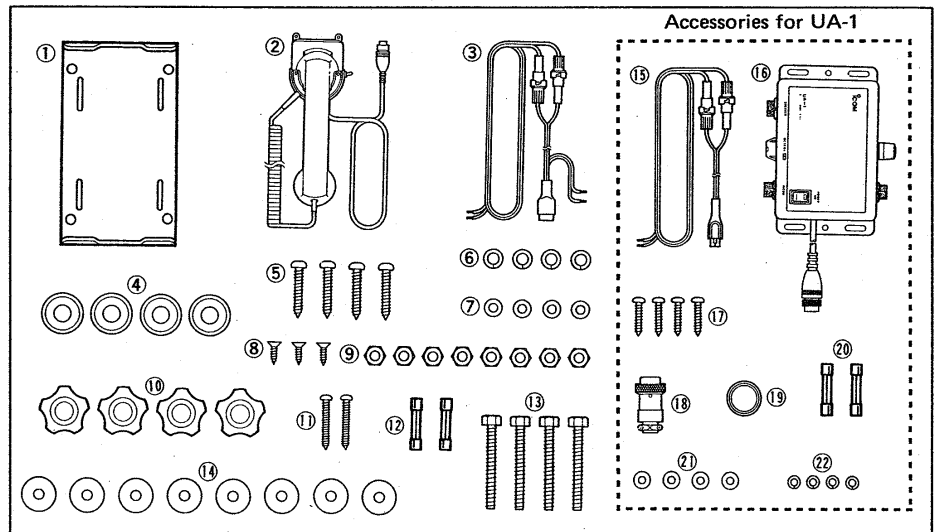

**Accessories included with the IC-M500D:**

	Qty.
① Mounting bracket . . . . .	1
② Handset kit (HS-50) . . . . .	1
③ DC power cable (OPC-191) for IC-M500D . . . . .	1
④ Rubber feet (C-30-CS-1) . . . . .	4
⑤ Self-tapping screws (Pan head A0 6 x 30 SUS) . . . . .	4
⑥ Spring washers (M6 SUS) . . . . .	4
⑦ Flat washers (M5 SUS) . . . . .	4
⑧ Self-tapping screws (For handset cradle installation) . . . . .	3
⑨ Nuts (M6 SUS) . . . . .	8
⑩ Knob bolts (G-type D-35 M5 x 10 SUS) . . . . .	4
⑪ Self-tapping screws (Pan head A0 3.5 x 30 SUS) . . . . .	2
⑫ Spare fuses (10A) . . . . .	2
⑬ Hex head bolts (M6 x 50 SUS) . . . . .	4
⑭ Flat washers (M6 t=1.6 D=20 SUS) . . . . .	8
⑮ DC power cable (OPC-044A) for UA-1 . . . . .	1
⑯ Audio amplifier (UA-1) . . . . .	1
⑰ Self-tapping screws (Pan head A0 4 x 20 SUS) . . . . .	4
⑱ Speaker plug (NS-1004-4P) . . . . .	1
⑲ Connector cover . . . . .	1
⑳ Spare fuses (10A) . . . . .	2
㉑ Flat washers (M4 Ni) . . . . .	4
㉒ Spring washers (M4 Ni) . . . . .	4

---

# TABLE OF CONTENTS

---

<b>1. CONTROL FUNCTIONS.....</b>	<b>1 ~ 4</b>	<b>6. SCANNING OPERATION.....</b>	<b>15 ~ 17</b>
1-1 FRONT PANEL.....	1	6-1 SCAN TYPES.....	15
1-2 FUNCTION DISPLAY.....	3	6-2 DIAL SCAN.....	15
1-3 REAR PANEL.....	4	6-3 MEMORY SCAN.....	16
1-4 UA-1 (AUDIO AMPLIFIER).....	4	6-4 WEATHER CHANNEL SCAN.....	16
<b>2. INSTALLATION.....</b>	<b>5 ~ 6</b>	6-5 LOCKOUT SCAN.....	17
2-1 MOUNTING THE TRANSCEIVER AND THE UA-1.....	5	<b>7. OTHER FUNCTIONS OPERATION. 18 ~ 20</b>	
2-2 REAR PANEL CONNECTIONS.....	6	7-1 DISPLAY DIMMER FUNCTION.....	18
<b>3. BASIC OPERATION.....</b>	<b>7 ~ 11</b>	7-2 DTMF FUNCTION.....	18
3-1 TURNING THE POWER ON AND OFF.....	7	7-3 DUPLEX FUNCTION.....	18
3-2 SELECTING CHANNEL 16.....	7	7-4 INTERCOM FUNCTION.....	19
3-3 SELECTING A CHANNEL.....	7	7-5 HAILER FUNCTION.....	20
3-4 RECEIVING.....	9	7-6 FOGHORN FUNCTION.....	20
3-5 TRANSMITTING.....	10	<b>8. MAINTENANCE.....</b>	<b>21 ~ 22</b>
3-6 OPERATING RULES AND GUIDELINES.....	11	8-1 TROUBLESHOOTING.....	21
<b>4. MEMORY CHANNEL OPERATION.....</b>	<b>12</b>	8-2 FUSE REPLACEMENT.....	22
4-1 SELECTING A MEMORY CHANNEL GROUP.....	12	8-3 RESETTING THE MICROPROCESSOR..	22
4-2 MEMORY READING.....	12	8-4 BACKUP BATTERY.....	22
4-3 MEMORY WRITING.....	12	8-5 CLEANING.....	22
<b>5. WATCH FUNCTION.....</b>	<b>13 ~ 14</b>	<b>9. VHF MARINE CHANNEL CHART.....</b>	<b>23</b>
5-1 CHANNEL WATCH TYPES.....	13	<b>10. SPECIFICATIONS.....</b>	<b>24</b>
5-2 DUAL WATCH.....	13		
5-3 TRI WATCH.....	14		

---

## IMPORTANT

---

1. Transmitting or testing while installing, servicing or maintaining a 2-way radio unit that may affect the proper operation of a 2-way radio station must be performed by or under the immediate supervision and responsibility of a person with a general radiotelephone operator's license or other such authorized license.
2. **DO NOT** operate both the IC-M500D and UA-1 without running the vessel's engine. The vessel's battery will be exhausted if the IC-M500D and UA-1 power are ON while your vessel's engine is OFF.
3. **Be careful!** If the IC-M500D or UA-1 are not securely mounted with bolts and nuts, personal injury or transceiver damage could occur due to wave shock, vibrations, etc.
4. Transmitting without an antenna will damage the transceiver.
5. Keep interconnection cables as far away as possible from electrical pumps, generators and other electronic instruments to prevent instrument malfunctions.

# 1 CONTROL FUNCTIONS

## 1-1 FRONT PANEL

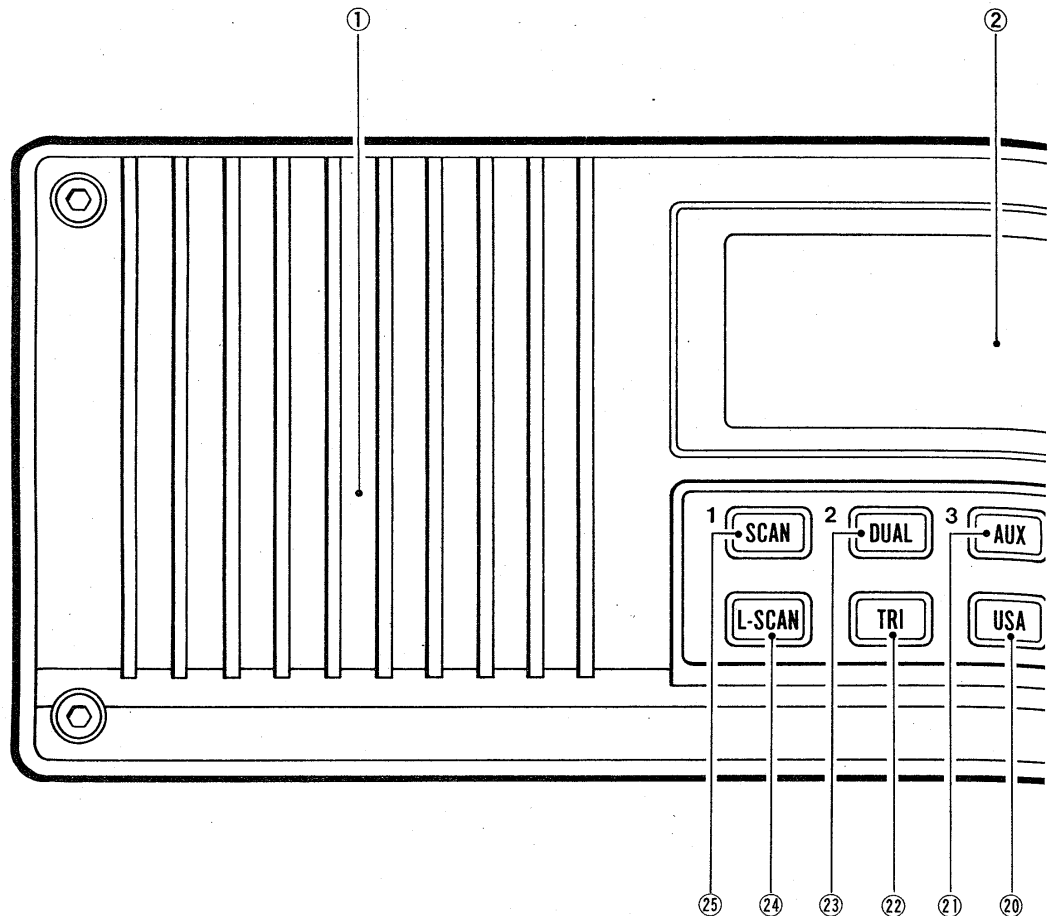

### ① INTERNAL SPEAKER

Operates when the transceiver is receiving or the INTERCOM is operating.

### ② FUNCTION DISPLAY

Indicates current operating channel and additional information. Refer to Section 1 - 2 FUNCTION DISPLAY.

### ③ CHANNEL SELECTOR

Selects an operating channel.

### ④ SQUELCH SET SWITCH

Varies the squelch threshold point.

The squelch threshold point is indicated by the SQUELCH LEVEL indicator on the FUNCTION DISPLAY.

### ⑤ VOLUME SET SWITCH

Varies the audio output level from the speaker.

The volume level is indicated by the VOLUME LEVEL indicator on the FUNCTION DISPLAY.

### ⑥ POWER SWITCHES

Turns ON the power when either switch is pushed, and turns OFF the power when both switches are pushed simultaneously.

### ⑦ CHANNEL 16 SWITCH

Selects Channel 16. This channel can be used as a call channel or as a marine distress and safety call channel.

### ⑧ DIAL SWITCH

Selects the DIAL mode.

### ⑨ WEATHER CHANNEL SWITCH

Selects the weather channels.

### ⑩ INTERCOM SWITCH

Selects the INTERCOM mode.

### ⑪ RF POWER SWITCH

Alternately selects HIGH and LOW transmit output power.

- HIGH : 25 W
- LOW : 1 W

### ⑫ HAILER SWITCH

Selects the HAILER mode. (Supplied UA-1 AUDIO AMPLIFIER must be connected.)

### ⑬ HIGH POWER SWITCH

Selects HIGH output transmit power while pushing and holding this switch when operating on Channels 13 and 67 on a U.S.A. channel.

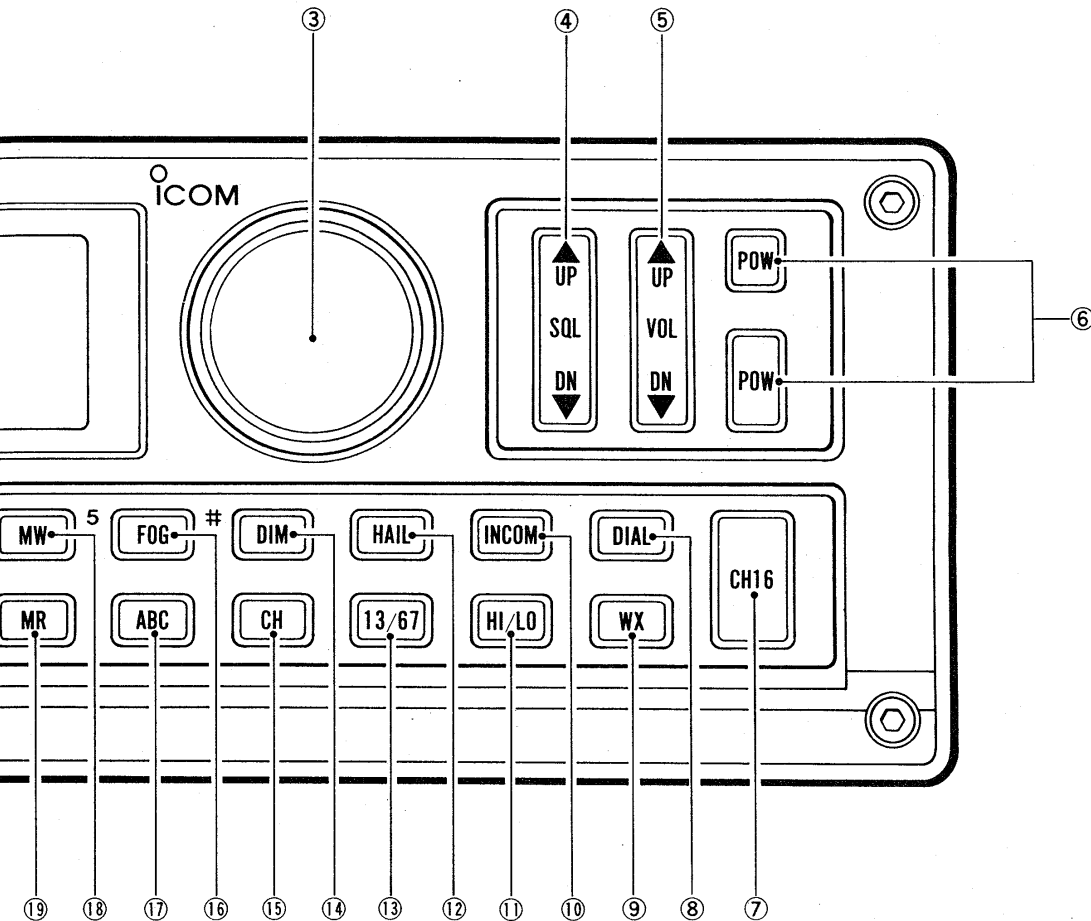

⑭ **DIMMER SWITCH**

Turns ON and OFF the FUNCTION DISPLAY backlight.

Varies backlight intensity at 8 levels when the CHANNEL SELECTOR is rotated while pushing and holding the [DIM] switch.

⑮ **DIRECT CALL SWITCH**

Turns ON the DIRECT CALL function.

To select the desired channel quickly, push the [CH] switch then push number keys on the keyboard.

⑯ **FOGHORN SWITCH**

Activates the foghorn when the supplied UA-1 AUDIO AMPLIFIER is connected.

⑰ **MEMORY CHANNEL GROUP SWITCH**

Selects memory channel group A, B or C.

Each group has 16 channels, and each channel can be selected with the CHANNEL SELECTOR.

⑱ **MEMORY WRITE SWITCH**

Stores the desired channel into memory channels.

⑲ **MEMORY READ SWITCH**

Selects the MEMORY mode.

⑳ **U.S.A. CHANNEL SWITCH**

Selects U.S.A. or International marine channels.

㉑ **AUXILIARY SWITCH**

No connection. This is an extra switch.

㉒ **TRI WATCH SWITCH**

Starts and stops the TRI WATCH function.

The transceiver monitors Channel 16 and Memory Channel 00 while listening to the current operating channel.

㉓ **DUAL WATCH SWITCH**

Starts and stops the DUAL WATCH function.

The transceiver monitors Channel 16 while listening to the current operating channel.

㉔ **LOCKOUT SCAN SWITCH**

Starts and stops the LOCKOUT scan.

㉕ **SCAN SWITCH**

Starts and stops the DIAL, MEMORY and WEATHER CHANNEL scan.

# 1 CONTROL FUNCTIONS

## 1-2 FUNCTION DISPLAY

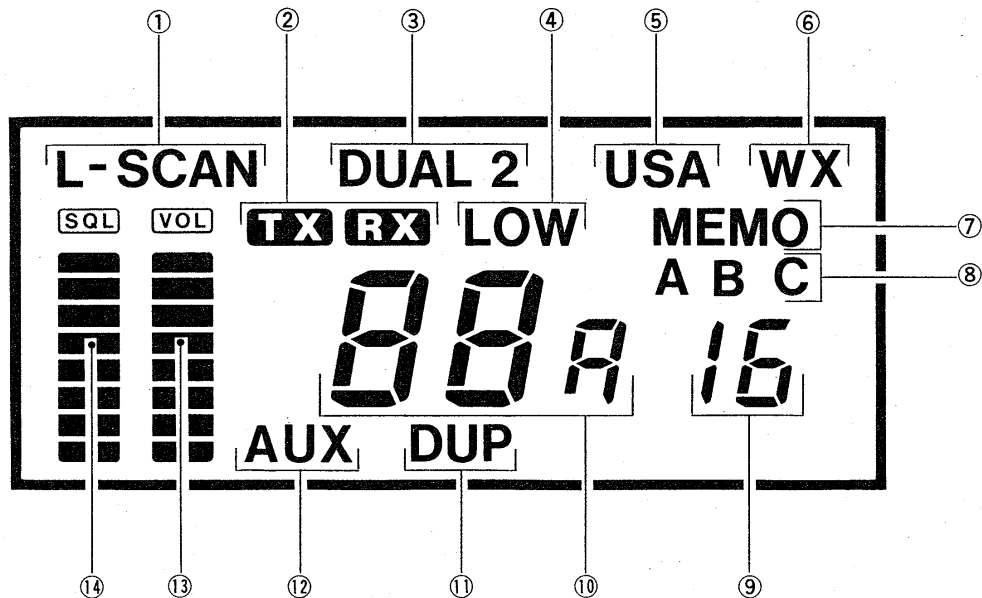

### ① SCAN INDICATORS

Appear while scanning.

- "SCAN" : Scan is operating.
- "L-SCAN" : LOCKOUT scan is operating.
- "L" : The displayed channel is programmed as a lockout channel.

### ② TRANSMIT/RECEIVE INDICATORS

When the transceiver is transmitting "TX" appears.

When the transceiver is receiving and the channel is busy "RX" appears.

### ③ DUAL AND TRI WATCH INDICATORS

Indicates that the DUAL or TRI WATCH function is operating.

- "DUAL" : DUAL WATCH is operating.
- "DUAL 2" : TRI WATCH is operating.

### ④ TRANSMIT POWER INDICATOR

Displays the operating output power.

- LOW power : "LOW" appears.
- HIGH power : No indication.

### ⑤ CHANNEL MODE INDICATOR

Displays channel modes such as U.S.A. or International marine channels.

- U.S.A. channel : "USA" appears.
- International channel : No display.

### ⑥ WEATHER CHANNEL INDICATOR

Lights while operating a weather channel.

### ⑦ MEMORY MODE INDICATOR

Appears when the transceiver selects the MEMORY mode.

### ⑧ MEMORY CHANNEL GROUP INDICATOR

Displays which memory channel group (A, B or C) has been selected.

### ⑨ MEMORY CHANNEL INDICATOR

Displays the memory channel number.

### ⑩ CHANNEL INDICATOR

Displays channel numbers.

### ⑪ DUP INDICATOR

Indicates the channel is for duplex operation.

### ⑫ AUXILIARY INDICATOR

Appears when the [AUX] switch is pushed.

### ⑬ VOLUME LEVEL INDICATOR

Displays the relative audio output level when receiving.

Displays the relative modulation level when transmitting.

### ⑭ SQUELCH LEVEL INDICATOR

Displays the relative squelch threshold level when receiving.

Displays the relative transmit output power selection when transmitting.

- LOW power : 2 bars appear.
- HIGH power : All bars appear.

## 1-3 REAR PANEL

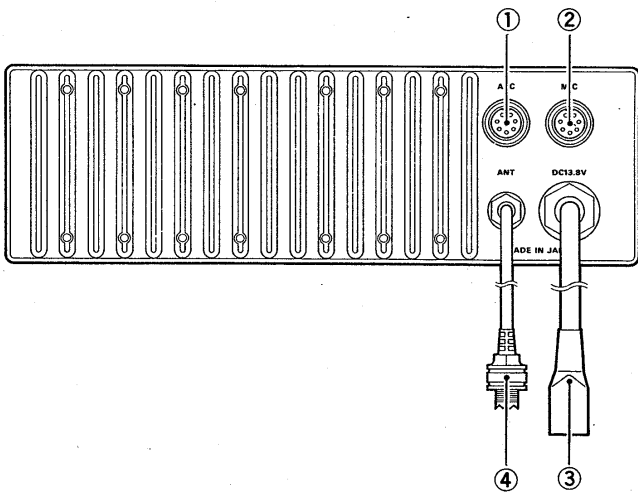

## ① ACC CONNECTOR

Accepts the supplied UA-1 AUDIO AMPLIFIER for operating the HAILER or INTERCOM functions. (See p. 6)

## ② MIC CONNECTOR

Connect the supplied handset or an optional EM-48 HAND MICROPHONE here.

## ③ DC POWER CONNECTOR

Connect the supplied DC power cable from this connector to an external 12V DC power source.

## ④ ANTENNA CONNECTOR

Connect an antenna cable here. The connector should be matched with a PL-259 plug.

**CAUTION:** Transmitting without an antenna will damage the transceiver.

## 1-4 UA-1 (AUDIO AMPLIFIER)

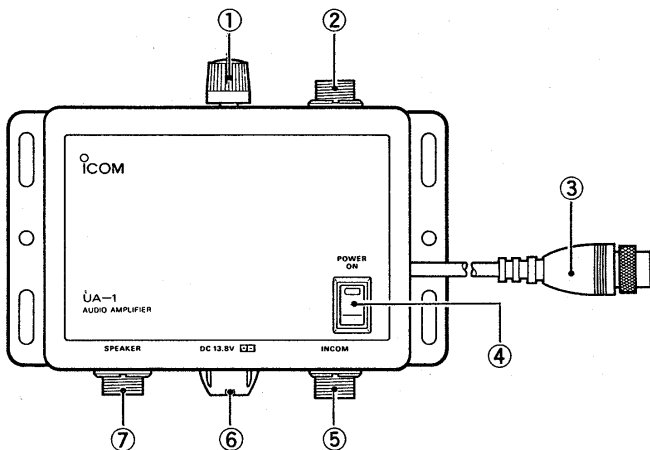

## ① VOLUME CONTROL

Varies the audio output power for operating the HAILER and FOGHORN functions.

- Max. audio output power : 30 W

## ② MIC CONNECTOR

Connects the supplied handset or optional EM-48 HAND MIC when operating the HAILER function without the IC-M500D.

## ③ CONTROL CABLE

Connects to the ACC CONNECTOR on the IC-M500D rear panel. Not necessary when operating the UA-1 without the IC-M500D.

## ④ POWER SWITCH

Turns ON and OFF the power. Be sure to turn OFF this switch whenever the UA-1 is not in use.

## ⑤ INTERCOM SPEAKER CONNECTOR

Connect the INTERCOM speaker here. See p. 6 for more information.

## ⑥ DC POWER CONNECTOR

Connect the supplied DC power cable from this connector to an external 12 V DC power source.

## ⑦ HAILER SPEAKER CONNECTOR

Connect the HAILER speaker here. See p. 6 for more information.

# 2 INSTALLATION

## 2-1 MOUNTING THE TRANSCEIVER AND THE UA-1

The universal bracket supplied with the IC-M500D allows "overhead" or "dashboard" mounting. Install the UA-1 as shown in the diagram at left.

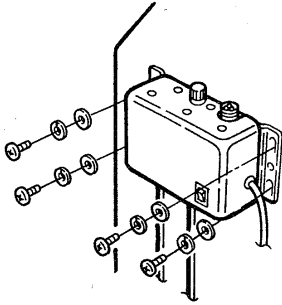

UA-1 Installation

- Install the bracket so the transceiver is adequately supported, thus protecting it from wave shock and vibrations.
- The mounting hardware supplied is suitable for most installations, but if you need special hardware, any good marine store can assist you.
- As with any marine installation, it is recommended that only high-quality marine hardware such as stainless steel be used.
- Try to avoid drilling new mounting holes in the bracket, because the balance of the transceiver may be affected.

### • OVERHEAD MOUNTING

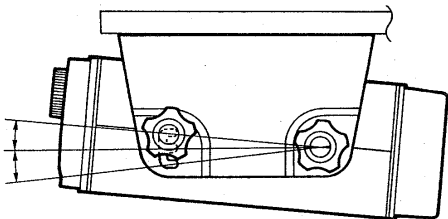
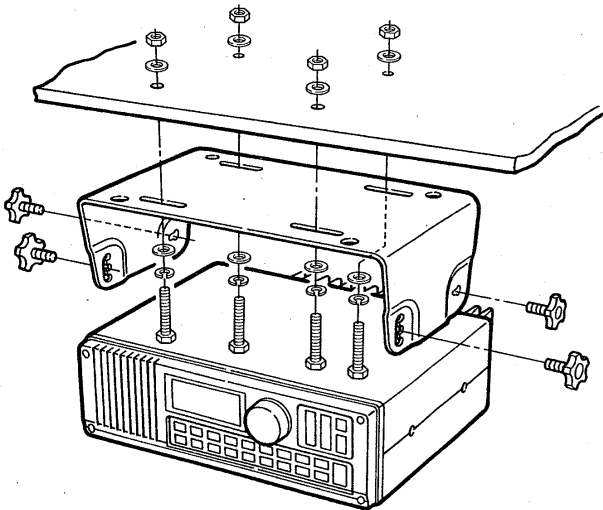
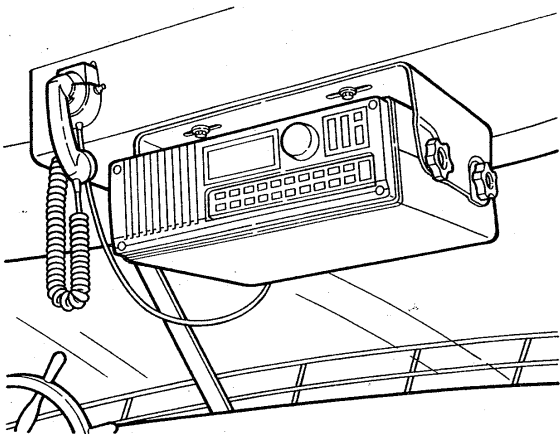

Adjust installation angle for good visibility.

### • DASHBOARD MOUNTING

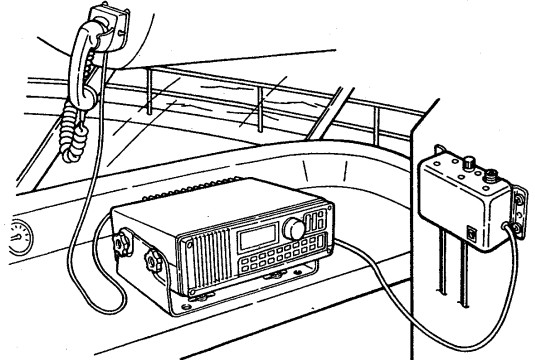

Use the supplied hardware to mount the transceiver to the dashboard.

### • PORTABLE USE

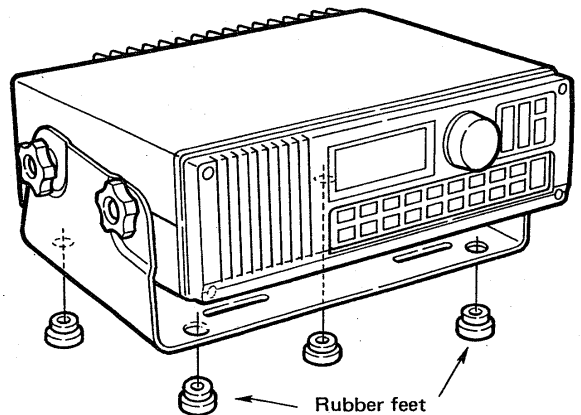

For convenient portable use, install the 4 rubber feet to the mounting bracket. Be sure the transceiver is securely fastened while your vessel is at sea.

**CAUTION:** Be careful! If the transceiver is not securely mounted with bolts and nuts, personal injury or transceiver damage could occur due to wave shock, vibrations, etc.



2-2 REAR PANEL CONNECTIONS

- AVOID long cable runs to the antenna, power source, and HAILER/INTERCOM.
- Keep these cables as far as possible from electrical pumps, generators and other electronic instruments.
- Keep the HAILER/INTERCOM cable and ANTENNA cable as far away from each other as possible.
- When cables (gray and black) for the external speaker are not used, tape the ends of both cables to insulate them from the transceiver body and boat chassis.

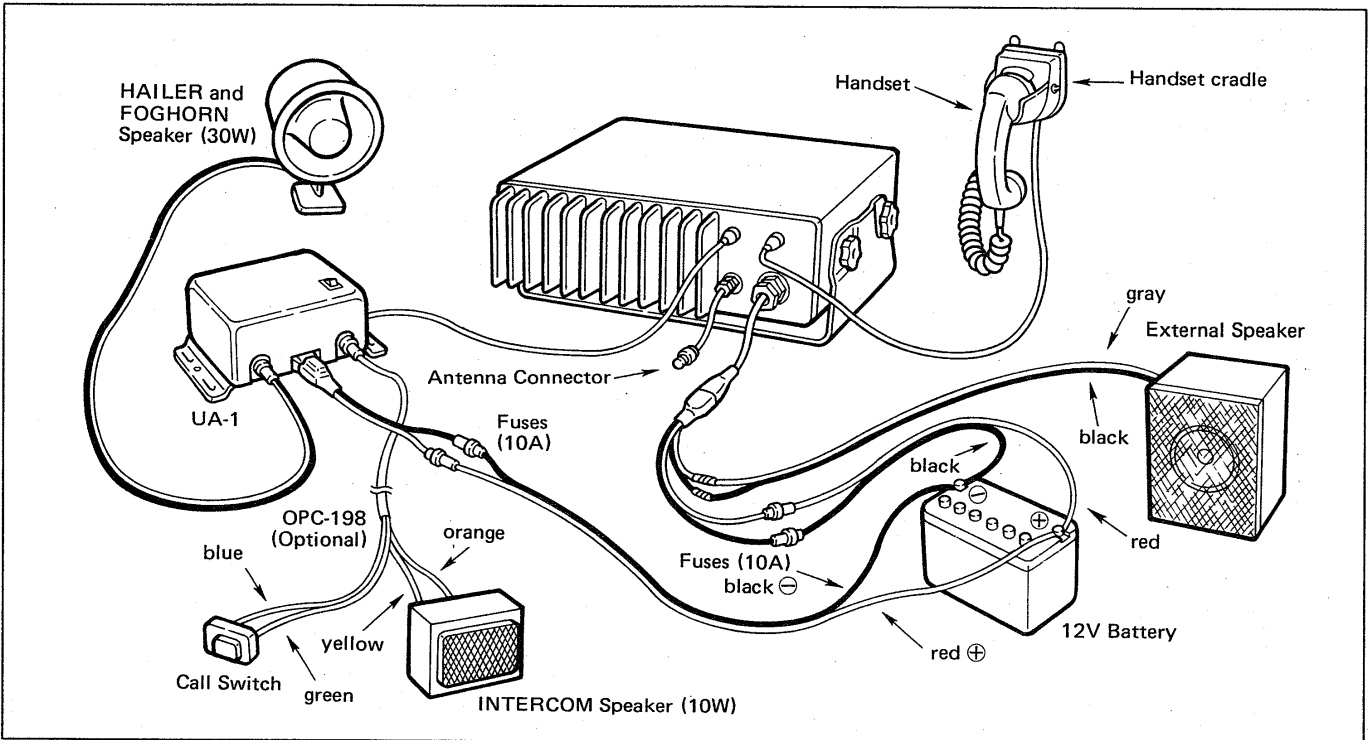

• SPEAKER PLUG CONNECTION

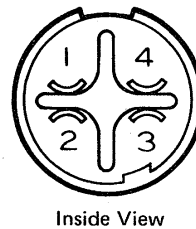
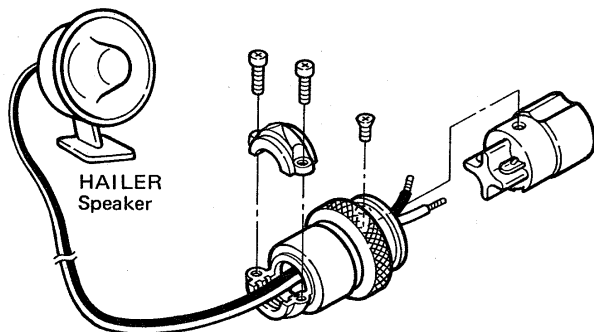

The UA-1 accepts a 4  $\Omega$ , 8  $\Omega$  or 16  $\Omega$  speaker. Solder speaker wires in the following way depending on speaker type.

PIN NUMBER	SPEAKER TYPE
1 and 4	16 $\Omega$
2 and 4	8 $\Omega$
3 and 4	4 $\Omega$

• OPC-198 INTERCOM CABLE CONNECTION (Optional)

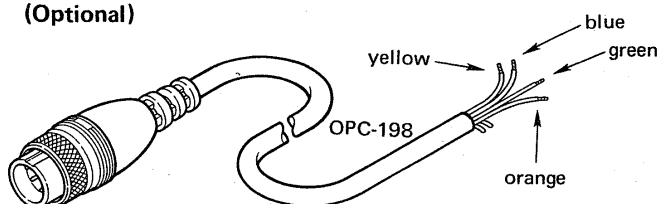

yellow, orange wires : To INTERCOM speaker  
blue, green wires : To Call Switch

# 3 BASIC OPERATION

## 3-1 TURNING THE POWER ON AND OFF

- 1) Push either [POW] switch to turn ON the power.
- 2) Push both [POW] switches simultaneously to turn OFF the power.

## 3-2 SELECTING CHANNEL 16

### (1) USING THE [POW] SWITCH

Use the [POW] or [CH 16] switch to select Channel 16.

- 1) Push either [POW] switch to turn ON the power.
  - The transceiver selects Channel 16 each time the power is turned ON.
- 2) The transceiver automatically selects Channel 16 when the handset is put back on the cradle.

### (2) USING THE [CH 16] SWITCH

- 1) Push the [CH 16] switch to select Channel 16 quickly when the FUNCTION DISPLAY indicates a channel other than Channel 16.
- 2) Push the [DIAL] switch to return to the previously displayed frequency.
  - The displayed marine channel can be changed in this condition.

## 3-3 SELECTING A CHANNEL

The IC-M500D has 2 ways of selecting a desired channel:

- CHANNEL SELECTOR
- DIRECT CALL function

### (1) USING THE CHANNEL SELECTOR

- 1) Turn the transceiver power ON.
- 2) Select a U.S.A., International or Weather channel by pushing a desired switch.
  - The [USA] switch alternately selects the U.S.A. and International marine channels.

#### ■ U.S.A. channel

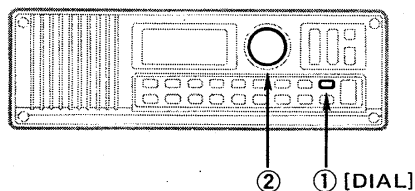

- ① Push the [DIAL] switch.
- ② Rotate the CHANNEL SELECTOR.

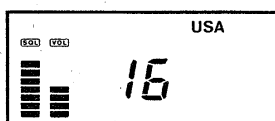

"USA" appears

#### ■ International channel

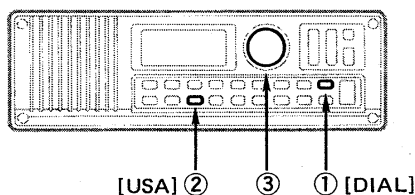

- ① Push the [DIAL] switch.
- ② Push the [USA] switch.
- ③ Rotate the CHANNEL SELECTOR.

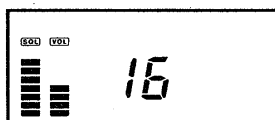

There is no indication for the International channel.

#### ■ Weather channel

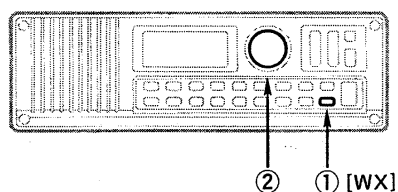

- ① Push the [WX] switch.
- ② Rotate the CHANNEL SELECTOR.

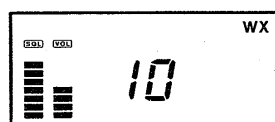

"WX" appears

**Example 1:** Selecting Channel 16 using the [CH16] switch.

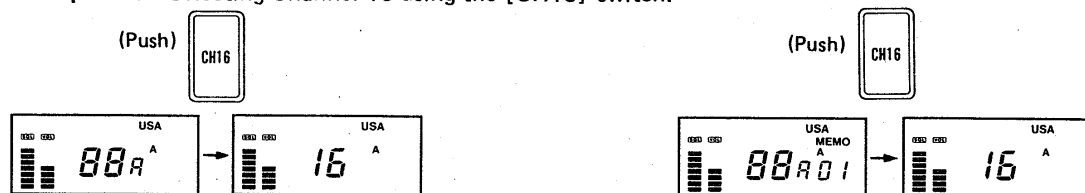

**Example 2:** Selecting Channel 22A on a U.S.A. channel.

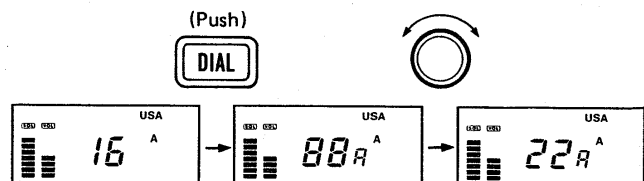

**Example 3:** Selecting Weather Channel 10.

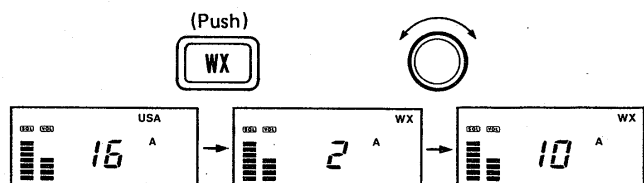

**(2) USING THE KEYBOARD**

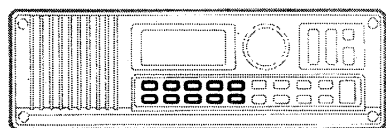

Number keys

- 1) Push either [POW] switch to turn ON the power.
- 2) Push the [DIAL] switch.
- 3) Push the [USA] switch to select either a U.S.A. or International channel.
- 4) Push the [CH] switch to turn ON the DIRECT CALL function.
  - The ten digit on the FUNCTION DISPLAY blinks.
- 5) Push the number switches to select the desired channel.

**Example 4:** Selecting Channel 22A and a U.S.A. channel with the DIRECT CALL function.

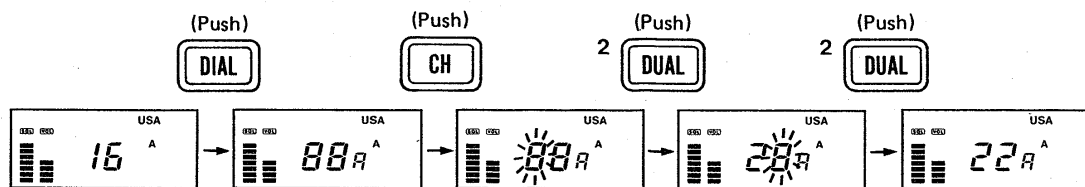

**Example 5:** Changing operating modes.

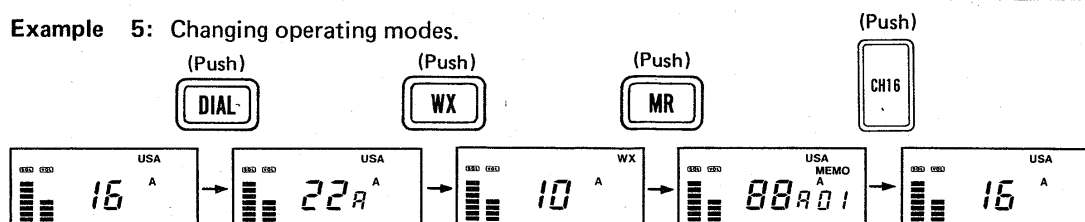

### 3 BASIC OPERATION

#### 3-4 RECEIVING

**NOTE:** The supplied handset **MUST** be connected to obtain receive audio.

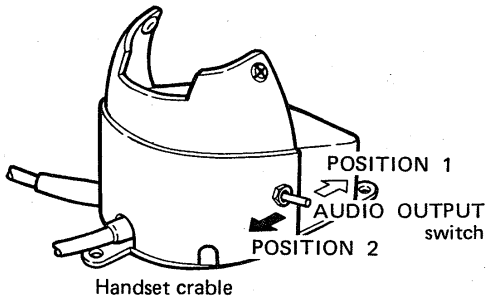

- 1) Push either [POW] switch to turn ON transceiver power.
- 2) Push the [UP] or [DN] on the [VOL] switch to obtain a suitable listening level.
  - The VOLUME LEVEL indicator shows the relative audio output level.
- 3) Select the audio output position with the AUDIO OUTPUT switch on the handset cradle.
  - ☒ (POSITION 1) : Output from the handset.
  - ☒ (POSITION 2) : Output from both the handset and speaker.
- 4) Push the [UP] or [DN] on the [SQL] switch until the speaker noise is just quieted.
- 5) The transceiver is now receiving on Channel 16.
  - To receive on another channel, see Section 3-3 SELECTING A CHANNEL.

#### • SQUELCH AND VOLUME SWITCHES NOTE

(1) Pushing the switch varies the level.

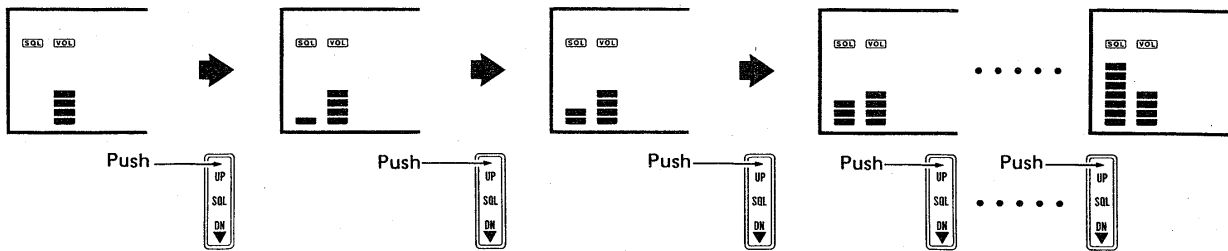

(2) Pushing and holding the switch varies the level continuously.

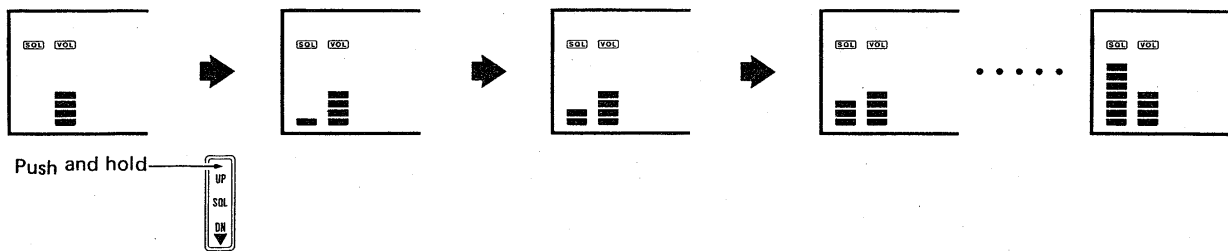

(3) Simultaneously pushing both [UP] and [DN] switches immediately reduces the control setting to the minimum level.

Pushing the [UP] switch returns the setting to the previous level.

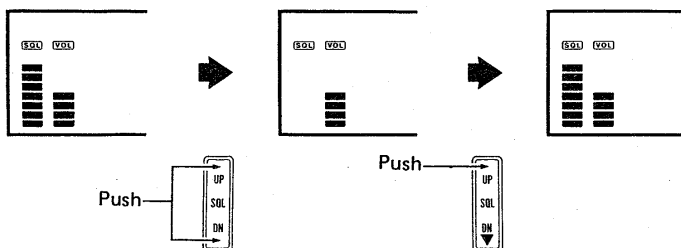

### 3-5 TRANSMITTING

The following transmitting procedures should be started after completing the steps described above in Section 3 - 4 RECEIVING.

See p. 18 for operating the duplex function.

**CAUTION:** Transmitting without an antenna will damage the transceiver.

- 1) Push either [POW] switch to turn ON power.
- 2) Select the desired operating channel. See Section 3 - 3 SELECTING A CHANNEL.
- 3) Push the [HI/LOW] switch to select the desired output power.
  - "LOW" appears when LOW power is selected.
  - There is no indication for the HIGH output power.

**NOTE:** On Channels 13 and 67, the transceiver automatically selects LOW output power. However, the transceiver can select HIGH output power by pushing and holding the [13/67] switch while transmitting.

- 4) Push the PTT switch to begin transmitting. Speak into the mouthpiece using your normal voice level.
  - When the FUNCTION DISPLAY indicates "DUP" for duplex operation, you can have conversations with other stations, using the handset like a telephone.
- 5) Put back the handset on the cradle after transmitting.
  - The transceiver automatically monitors Channel 16 when the transceiver has selected a channel other than Channel 16.

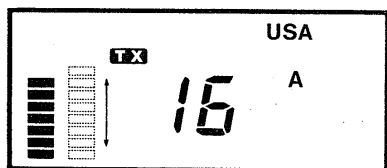
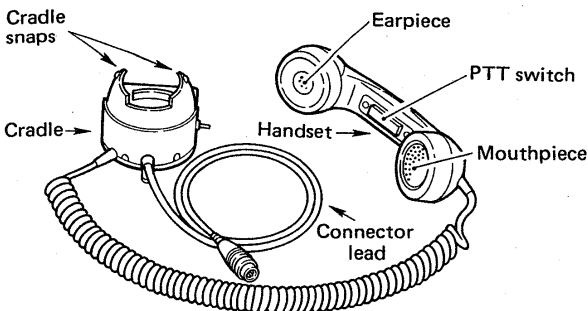

Indication level varies with your voice level.



**Q. How far does a signal reach when transmitted over a sea or lake?**

**A.** For practical purposes, there is very little signal propagation beyond the line-of-sight range when using VHF frequencies.

In theory, the distance of possible communication between 2 stations is obtained using the following formula:

$$D \text{ (nm)} = 1.22 \times (\sqrt{h_1} + \sqrt{h_2})$$

- D : Distance
- h1 : Antenna height (ft)
- h2 : Antenna height (ft)

For instance, where h1 = 8 ft and h2 = 8 ft, the distance is:

$$\begin{aligned} D \text{ (nm)} &= 1.22 \times (\sqrt{8} + \sqrt{8}) \\ &= \text{Approx. } 7 \text{ nm} \\ &= \text{Approx. } 8 \text{ miles} \end{aligned}$$

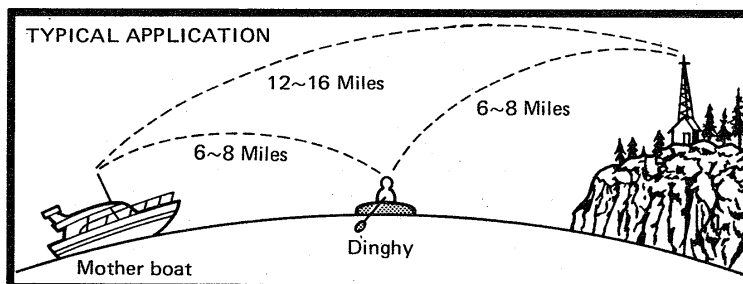

Depending on weather conditions and your location, some signals may not reach 8 miles and others may extend beyond 8 miles.

## 3 BASIC OPERATION

### 3-6 OPERATING RULES AND GUIDELINES

#### (1) CALL PROCEDURES

Before transmitting, monitor the channel you wish to use to avoid interrupting transmissions already in progress.

Calls must be properly identified and time limits must be respected.

- 1) Give your call sign each time you call another vessel or a coast station. If you have no call sign, identify the station by giving the vessel name and the name of the licensee.
- 2) Give your call sign at the end of each transmission that lasts more than three minutes.
- 3) You must break and give your call sign at least once every fifteen minutes during long ship-to-shore calls.
- 4) Keep your unanswered calls short (less than thirty seconds). Wait two minutes before repeating the call.
- 5) Unnecessary transmissions are not allowed.

#### (2) PRIORITIES

- 1) Read all the rules and regulations pertaining to priorities and keep an up-to-date copy handy. Safety and distress calls take priority over all others.
- 2) You must monitor and be able to transmit on Channel 16.
- 3) False or fraudulent distress signals are prohibited and punishable by law.

#### (3) PRIVACY

- 1) Information overheard but not intended for you cannot lawfully be used in any way.
- 2) Indecent or profane language is prohibited.

#### (4) RADIO LICENSES

##### 1) Ship Station License

When your craft is equipped with a VHF FM transceiver such as the IC-M500D you must have a current radio station license before using the equipment. It is unlawful to operate a ship station which is not licensed.

Inquire through your dealer or the appropriate government agency for a Ship-Radiotelephone License application. Your government-issued license states the call sign which is your craft's identification for radio purposes.

##### 2) Operator's License

A restricted Radiotelephone Operator Permit is the license most often held by small vessel radio operators when a radio is not required for safety purposes. You can usually obtain this permit by mail.

The Restricted Radiotelephone Operator Permit must be posted near the transceiver or kept with the operator. Only a licensed radio operator may operate a transceiver.

However, non-licensed individuals may talk over a transceiver if a licensed operator starts, supervises, and ends the call, and makes the necessary log entries.

A current copy of the applicable government rules and regulations is unusually required to be kept.

# MEMORY CHANNEL OPERATION 4

## 4-1 SELECTING A MEMORY CHANNEL GROUP

The IC-M500D has 3 memory channel groups. There are three separate groups of 16 memory channels (48 channels total) available for storing information. This system is useful for:

- customizing channel allocations.
- finding the desired channels easily.

- 1) Push the [DIAL] switch.
- 2) Push the [ABC] switch and select the desired memory channel group.
  - Each push of the [ABC] switch changes the memory channel group.
- 3) Rotate the CHANNEL SELECTOR to select the desired channel.

## 4-2 MEMORY READING

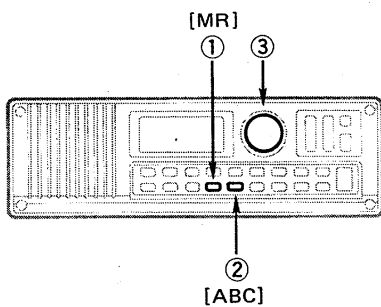

- 1) Push the [MR] switch to select the MEMORY mode.
- 2) Push the [ABC] switch to select the desired memory channel group.
- 3) Rotate the CHANNEL SELECTOR to select the desired channel.

**NOTE:** When the memory channels are blank, "00" is displayed even if the CHANNEL SELECTOR is rotated.

**Example 6:** Selecting memory channels.

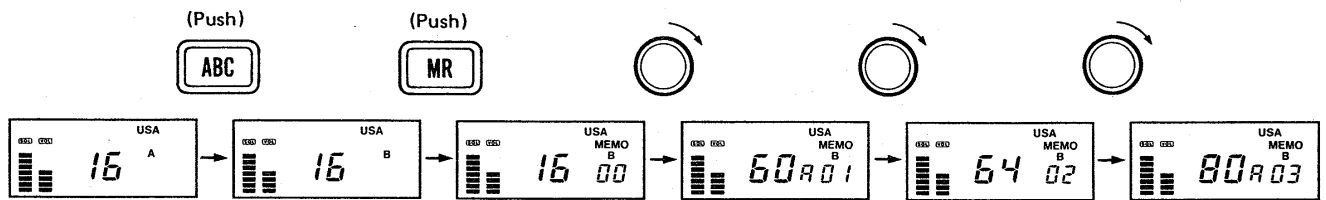

## 4-3 MEMORY WRITING

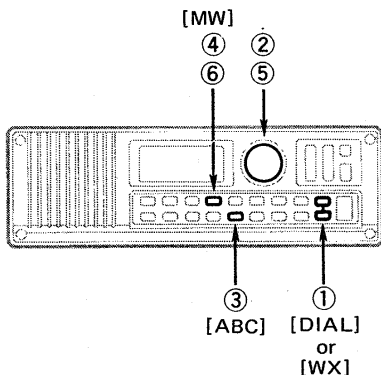

- 1) Push the [DIAL] or [WX] switch to select DIAL or WEATHER CHANNEL mode.
- 2) Rotate the CHANNEL SELECTOR to select the desired channel you want to memorize.
- 3) Push the [ABC] switch to select the desired channel group.
- 4) Push and hold the [MW] switch for approximately 2 seconds.
  - "MEMO" blinks.
- 5) Rotate the CHANNEL SELECTOR to select the desired memory channel number.
- 6) Push the [MW] switch to memorize the selected channel.

**Example 7:** Memorizing Channel 22A into Memory Channel 02 in Channel Group A.

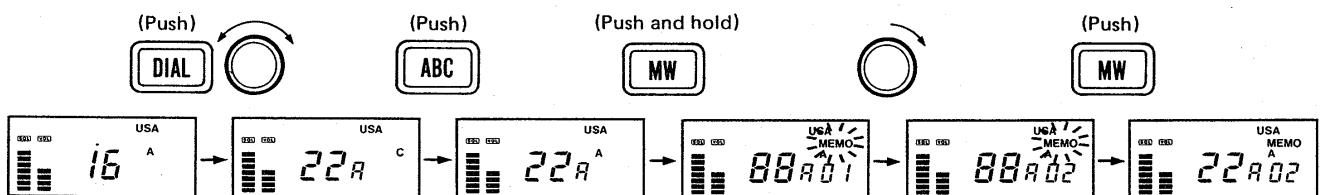

# 5 WATCH FUNCTION

## 5-1 CHANNEL WATCH TYPES

The IC-M500D is equipped with 2 channel watch functions, providing a check of Channel 16 while listening on other channels.

CHANNEL WATCH TYPE	OPERATION
DUAL WATCH	Monitors Channel 16 while listening on other channels.
TRI WATCH	Monitors Channel 16 and Memory Channel 00 while listening on another channel.

**• DUAL WATCH SIMULATION**

• If a signal appears on Channel 16, the transceiver receives on Channel 16 until the signal disappears.

**• TRI WATCH SIMULATION**

① If a signal appears on Channel 16, the transceiver functions the same as in DUAL WATCH operation.  
 ② If a signal appears on MEMO-00, the transceiver receives MEMO-00 while listening on Channel 16.

## 5-2 DUAL WATCH

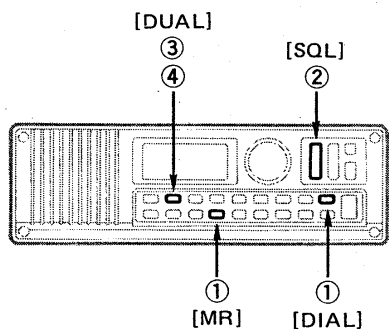

- 1) Push either the [DIAL] or [MR] switch and select the desired operating channel. See Section 3 - 3 SELECTING A CHANNEL.
- 2) Push the [UP] or [DN] on the [SQL] switch until the speaker noise is just quieted.
- 3) Push the [DUAL] switch to start the DUAL WATCH function.
  - "DUAL" blinks on the FUNCTION DISPLAY.
  - The transceiver monitors Channel 16 and the channel selected in step 1) above.
  - When the PTT switch is pushed, the transceiver transmits on the displayed channel.
- 4) Push the [DUAL] switch again to cancel the function.
  - "DUAL" disappears from the FUNCTION DISPLAY.
  - The following switches also cancel the function: [SCAN] [TRI] [L-SCAN]

**Example 8:** Operating the DUAL WATCH function on Channel 17.

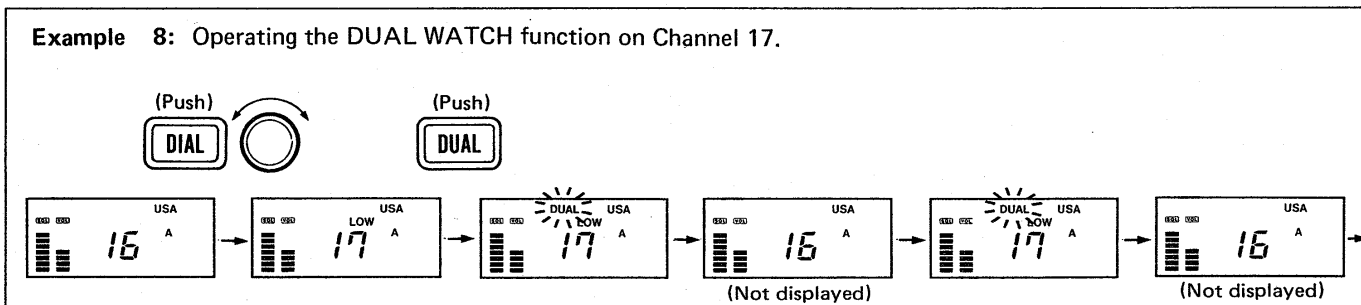



## 5-3 TRI WATCH

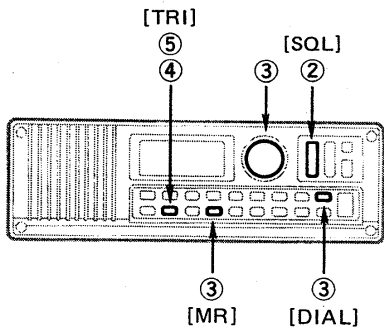

- 1) Program the desired channel for monitoring Memory Channel 00 in the desired channel group. (See p. 12 for memory writing information.)
- 2) Push the [UP] or [DN] on the [SQL] switch until the speaker noise is just quieted.
- 3) Push either the [DIAL] or [MR] switch and select the desired operating channel. See Section 3 - 3 SELECTING A CHANNEL.
- 4) Push the [TRI] SWITCH to start the TRI WATCH function.
  - "DUAL 2" blinks on the FUNCTION DISPLAY.
  - The transceiver monitors Channel 16, Memory Channel 00 in the displayed memory channel group and the displayed channel.
  - When the PTT switch is pushed, the transceiver transmits on the displayed channel.
- 5) Push the [TRI] switch again to cancel the function.
  - "DUAL 2" disappears from the FUNCTION DISPLAY.
 The following switches also cancel the function:  
 [SCAN] [L-SCAN] [DUAL]

**Example 9:** Operating the TRI WATCH function on Channel 17. The contents of Channel 60A are stored in Memory Channel 00 in Channel Group A.

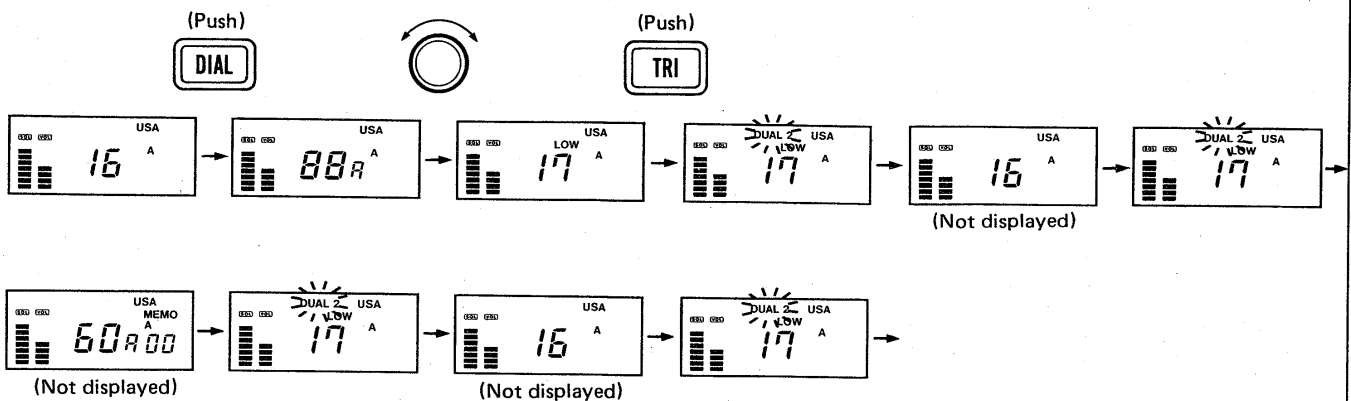

# 6 SCANNING OPERATION

## 6-1 SCAN TYPES

The IC-M500D is equipped with separate scan functions which provide tremendous scanning versatility at the touch of a few switches.

The transceiver monitors Channel 16 while scanning in any type of scan.

SCAN TYPE	SWITCH	DESCRIPTION
DIAL SCAN	[DIAL] + [SCAN]	Scans all marine channels in the current operating mode.
MEMORY SCAN	[MR] + [SCAN]	Scans all memory channels in the current operating memory channel group.
WEATHER CHANNEL SCAN	[WX] + [SCAN]	Scans all weather channels.
DIAL LOCKOUT SCAN	[DIAL] + [L-SCAN]	Scans all marine channels in the current operating mode while skipping programmed lockout channels.
MEMORY LOCKOUT SCAN	[MR] + [L-SCAN]	Scans all memory channels in the current operating memory channel group while skipping programmed lockout channels.

## 6-2 DIAL SCAN

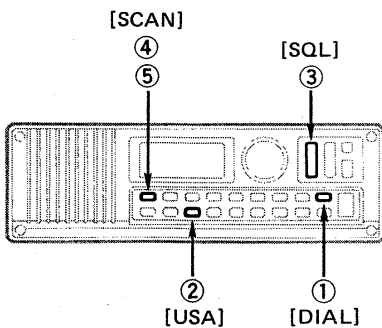

- 1) Push the [DIAL] switch to select DIAL mode.
- 2) Push the [USA] switch to select either a U.S.A. or International channel.
- 3) Push the [UP] or [DN] on the [SQL] switch until the speaker noise is just quieted.
- 4) Push the [SCAN] switch to start the scan.
  - "SCAN" appears on the FUNCTION DISPLAY.
  - Channel numbers change.
  - The scan stops when a signal is received.
  - The scan resumes after the signal disappears.
- 5) Push the [SCAN] switch again to stop the scan.
  - The following switches also stop the scan: [PTT] [DUAL] [TRI] [DIAL]

### Example 10: Operating DIAL scan.

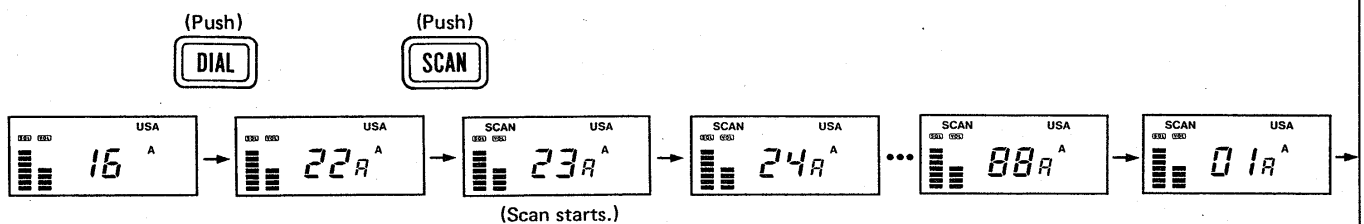

### 6-3 MEMORY SCAN

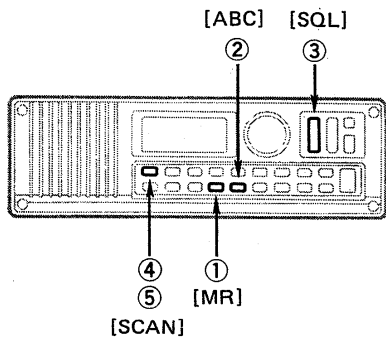

- 1) Push the [MR] switch to select MEMORY mode.
  - "MEMO", the channel group and memory channel number appear on the FUNCTION DISPLAY.
- 2) Push the [ABC] switch to select the desired channel group.
- 3) Push the [UP] or [DN] on the [SQL] switch until the speaker noise is just quieted.
- 4) Push the [SCAN] switch to start the scan.
  - "SCAN" appears on the FUNCTION DISPLAY.
  - Memory channel numbers change.
  - The scan stops when a signal is received.
  - The scan resumes after the signal disappears.
- 5) Push the [SCAN] switch again to stop the scan.
  - The following switches also stop the scan: [PTT] [DUAL] [TRI] [L-SCAN] [MR]

**Example 11:** Operating MEMORY scan in Channel Group B.

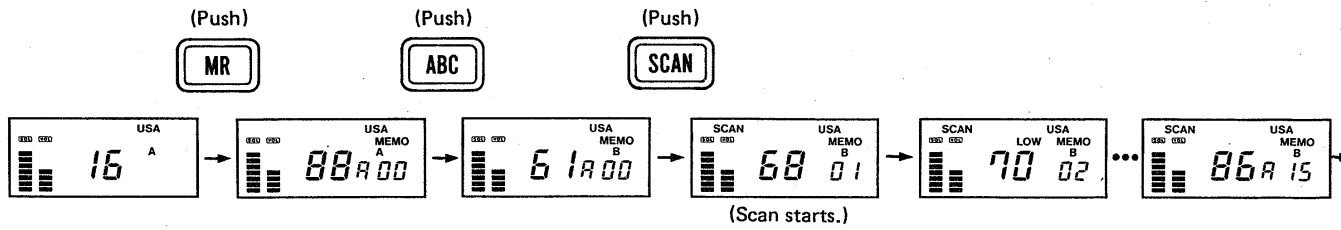

### 6-4 WEATHER CHANNEL SCAN

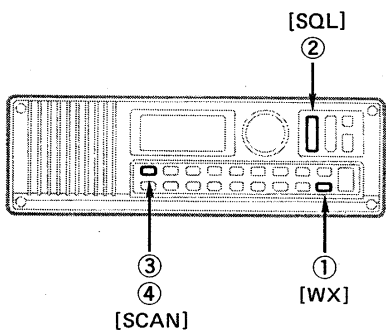

- 1) Push the [WX] switch to select WEATHER CHANNEL mode.
- 2) Push the [UP] or [DN] on the [SQL] switch until the speaker noise is just quieted.
- 3) Push the [SCAN] switch to start the scan.
  - "SCAN" appears on the FUNCTION DISPLAY.
  - Weather channel numbers change.
  - The scan stops when a signal is received.
  - The scan resumes after the signal disappears.
- 4) Push the [SCAN] switch again to stop the scan.
  - The following switches also stop the scan: [PTT] [DUAL] [TRI] [L-SCAN] [WX]

**Example 12:** Operating WEATHER CHANNEL scan.

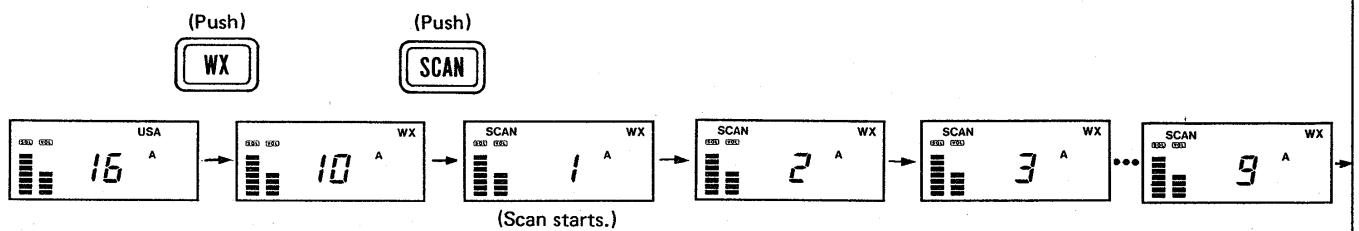

## 6 SCANNING OPERATION

### 6-5 LOCKOUT SCAN

This function allows you to skip unnecessary channels while scanning, shortening interval scanning time.

#### (1) LOCKOUT CHANNEL PROGRAMMING

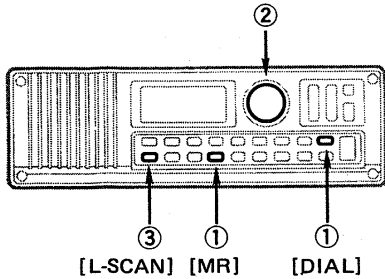

- 1) Push either the [DIAL] or [MR] switch to select the desired mode.

**NOTE:** The LOCKOUT scan does not function in WEATHER CHANNEL mode.

- 2) Select the desired channel number to lock out. See Section 3 - 3 SELECTING A CHANNEL.
- 3) Push and hold the [L-SCAN] switch for approximately 2 seconds.
  - "L-SCAN" appears then "L" lights.
  - The displayed channel is locked out.
- 4) To unlock a channel, repeat steps 1 to 3.

**Example 13:** Programming a lockout channel on Channel 65A in Channel Group A and operating DIAL scan with the channel lockout function.

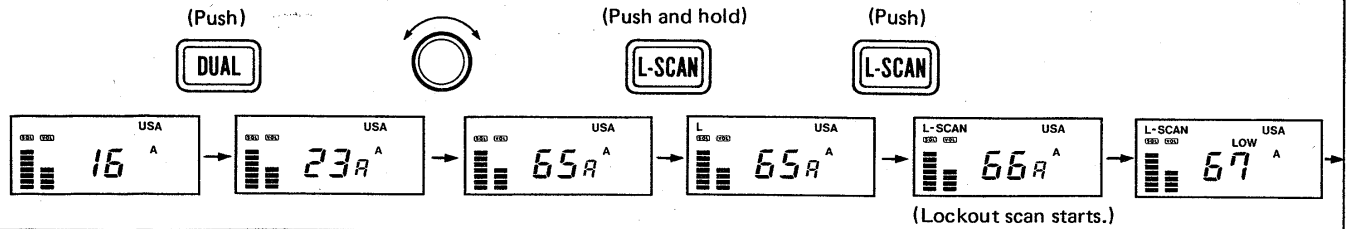

#### (2) LOCKOUT SCAN OPERATION

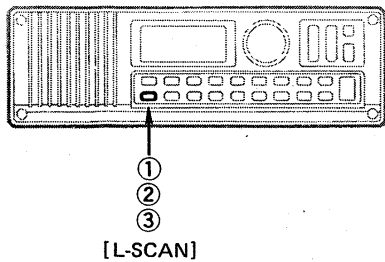

- 1) Push the [L-SCAN] switch to start the scan. The locked out channel is skipped.
- 2) Push the [L-SCAN] switch again to stop the scan.
  - The following switches also stop the scan:  
[SCAN] [DUAL] [TRI]
- 3) Select the locked out channel to be canceled, then push and hold the [L-SCAN] switch for approximately 2 seconds to cancel the channel.
  - "L" disappears.

**Example 14:** Programming a lockout channel on Memory Channel 03 in Channel Group A and operating MEMORY scan with the channel lockout function.

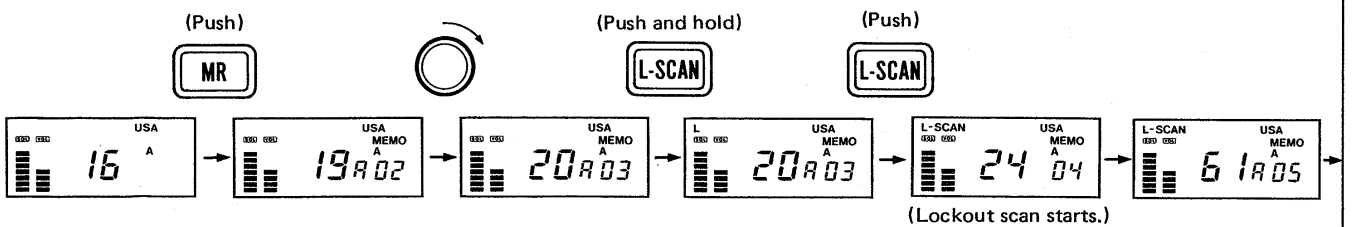

## 7-1 DISPLAY DIMMER FUNCTION

The IC-M500D has an illuminated FUNCTION DISPLAY for easy reading in darkness. The backlight may be turned ON and OFF, and the intensity may be varied to suit the ambient light conditions.

### (1) BACKLIGHT ON AND OFF

Push the [DIM] switch to turn the backlight ON and OFF.

### (2) BACKLIGHT INTENSITY

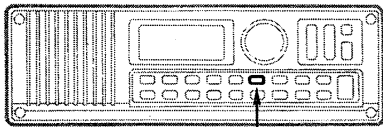

[DIM]

1) Push and hold the [DIM] switch, and then rotate the CHANNEL SELECTOR when the backlight is turned OFF.

- The FUNCTION DISPLAY intensity has 8 levels.

2) Release the [DIM] switch.

3) The transceiver remains at the previously displayed light condition after the transceiver power is turned OFF and then ON again.

**Example 15:** Changing the backlight intensity.

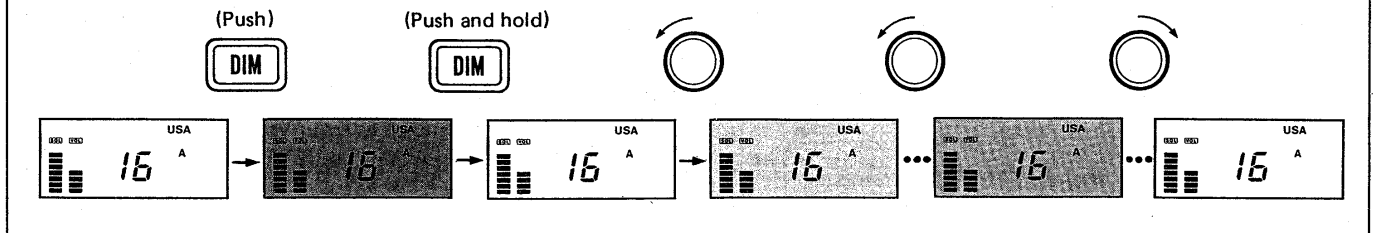

## 7-2 DTMF FUNCTION

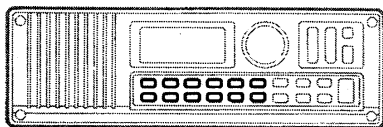

Number keys

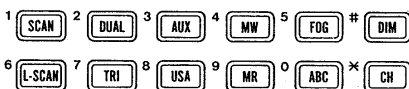

If you need DTMF (Dual Tone Multiple Frequency) tones to make an auto phone-patch, etc., follow the procedure below.

1) Push keys the desired number of times while pushing the PTT switch on the microphone.

- Telephone tones are transmitted and emitted from the internal speaker.

2) After the first number is entered, the transceiver remains in transmit condition for about one second.

## 7-3 DUPLEX FUNCTION

The IC-M500D is designed for duplex operation. Using duplex operation you can receive or transmit simultaneously with coast stations or repeaters, just like having a telephone conversation.

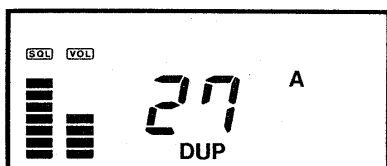

"DUP" appears.

**NOTE:** Ship-to-ship communication cannot be made on the duplex channel indicated by the "DUP" on the FUNCTION DISPLAY.

1) Push the [DIAL] switch.

2) Select the desired channel indicated by the "DUP" on the FUNCTION DISPLAY. See Section 3 - 3 SELECTING A CHANNEL.

3) Push and hold the PTT switch on the handset and speak into the mouthpiece.

- You may release the PTT switch when you do not speak.
- See p. 10 for transmitting procedures.

## 7 OTHER FUNCTIONS OPERATION

### 7-4 INTERCOM FUNCTION

#### (1) PREPARATION

The INTERCOM function allows you to receive an answer from the deck or another cabin to your hailer message via the IC-M500D internal speaker or earpiece of the handset.

- 1) The INTERCOM function is activated with or without the UA-1.
  - Connect the plug of the OPC-198 INTERCOM CABLE (sold separately) to the UA-1 when operating with the UA-1.
  - Connect the OPC-198 plug to the ACC CONNECTOR on the IC-M500D rear panel directly when operating without the UA-1.
- 2) Connect a switch and speaker to either [ACC] CONNECTOR on the IC-M500D rear panel or [INCOM] CONNECTOR on the UA-1, through an OPC-198 INTERCOM CABLE (sold separately). See p. 6 for connection procedures.
  - Speaker : More than 10 W
  - Switch : Unlocked type

#### (2) OPERATION FROM THE TRANSCEIVER

- 1) Turn the power ON.
- 2) Push the [INCOM] switch to select INTERCOM mode.
  - "IC" appears on the FUNCTION DISPLAY.
- 3) Push the PTT switch on the handset and speak at a normal level into the mouthpiece.
  - The intercom speaker emits the sound of your voice.
  - The transceiver does not transmit when the INTERCOM function is in use.
- 4) Push the [UP] or [DN] switch on the [VOL] switch to adjust the audio output level.
- 5) Release the PTT switch to hear the response from the deck.
  - Push [UP] or [DN] on the [VOL] switch to obtain a suitable listening level.
- 6) Push the [INCOM] switch to return to normal operations.
  - The following switches also return the transceiver to normal operations: [MR] [DIAL] [WX] [CH 16]

#### (3) OPERATION FROM THE DECK

The INTERCOM function can also be controlled on deck.

- 1) To call the cabin from the deck, activate the Call Switch and speak into the speaker. The Call Switch must be purchased separately.
- 2) Release the Call Switch to return the IC-M500D to cabin control of the intercom function.

Example 16: Operating the INTERCOM function.

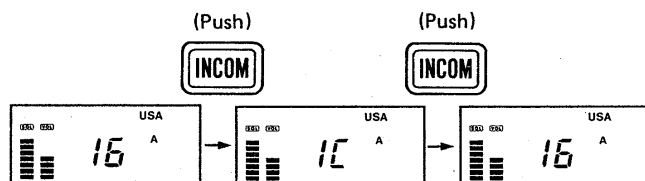

## 7-5 HAILER FUNCTION

The IC-M500D has a two-way hailer function for voice amplifying and receiving over the loudspeaker - making it unnecessary to leave the bridge to hear the hailing party.

### (1) PREPARATION

Connect the supplied UA-1 and speaker (sold separately) using the supplied speaker plug as shown in the diagram on p. 6.

- Speaker : Either 4, 8 or 16  $\Omega$  with more than 30 W.

### (2) OPERATION

- 1) Turn both the IC-M500D and UA-1 power ON.
- 2) Push the [HAIL] switch to select HAILER mode.
  - "HL" appears on the FUNCTION DISPLAY.
  - The displayed operating channel number moves to the right side of the FUNCTION DISPLAY.
  - A decimal point appears to the right side of the channel number when the transceiver has selected a channel with "A" appearing.
- 3) Push the PTT switch on the handset and speak at a normal level into the mouthpiece.
  - The hailer speaker emits the sound of your voice.
  - The transceiver does not transmit when the HAILER function is in use.
- 4) Adjust the [VOLUME] control on the UA-1 to obtain a suitable output level from the hailer speaker.
- 5) Push the [HAIL] switch again to return to normal operations.
  - The following switches also return the transceiver to normal operations: [MR] [DIAL] [WX] [CH 16]

Example 17: Operating the HAILER function.

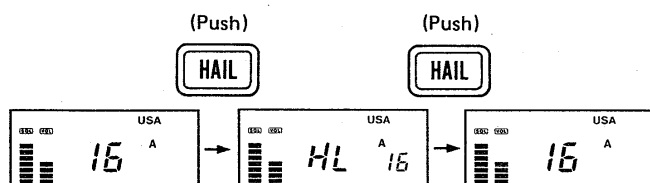

## 7-6 FOGHORN FUNCTION

The IC-M500D has a built-in foghorn function which simulates the sound of a foghorn.

**NOTE:** The FOGHORN function does not work when the transceiver is set for HAILER or INTERCOM operations.

### (1) PREPARATION

Connect the supplied UA-1 and speaker (sold separately) using the supplied speaker plug as shown in the diagram on p. 6.

- Speaker : Either 4, 8 or 16  $\Omega$  with more than 30 W.



### (2) OPERATION

- 1) Turn both the IC-M500D and UA-1 power ON.
- 2) Push and hold the [FOG] switch to emit a foghorn sound from the external speaker.
  - Foghorn sounds are emitted while the switch is pushed.
- 3) Adjust the [VOLUME] control on the UA-1 to obtain a suitable output level from the foghorn speaker.

# 8 MAINTENANCE

## 8-1 TROUBLESHOOTING

The following chart is designed to help you correct problems which are not equipment malfunctions. If you are not able to locate the cause of a problem or solve it through the use of this chart, contact your nearest Icom Service Center or Dealer.

PROBLEM	POSSIBLE CAUSE	SOLUTION
<ul style="list-style-type: none"> <li>Power does not come ON when a [POW] switch is pushed.</li> </ul>	<ul style="list-style-type: none"> <li>Power cable is improperly connected.</li> <li>Fuse is blown.</li> </ul>	<ul style="list-style-type: none"> <li>Reconnect the power cable securely.</li> <li>Check for the cause, then replace the fuse. (See p. 22)</li> </ul>
<ul style="list-style-type: none"> <li>No sound comes from the earpiece or internal speaker.</li> </ul>	<ul style="list-style-type: none"> <li>Volume level is set too low.</li> <li>The squelch is closed.</li> <li>The transceiver functions in HAILER mode.</li> <li>The transceiver functions in INTERCOM mode.</li> <li>Handset is not plugged into the MIC CONNECTOR.</li> <li>The toggle switch on the handset cradle is in the  position.</li> </ul>	<ul style="list-style-type: none"> <li>Push and hold [UP] on the [VOL] switch to obtain a suitable listening level. (See p. 9)</li> <li>Push and hold [DN] on [SQL] switch to open the squelch. See p. 9 for the squelch setting. (See p. 9)</li> <li>Push [HAIL] or [DIAL] switch when "HL" appears on the FUNCTION DISPLAY.</li> <li>Push [INCOM] or [DIAL] switch when "IC" appears on the FUNCTION DISPLAY.</li> <li>Plug the handset into the MIC CONNECTOR on the rear panel.</li> <li>Flip the switch to the  position. Sound comes from both the earpiece and internal speaker. (See p. 9)</li> </ul>
<ul style="list-style-type: none"> <li>Sensitivity is low and only strong signals are audible.</li> </ul>	<ul style="list-style-type: none"> <li>The antenna feedline is cut or shorted.</li> <li>Bad connection of the antenna connector.</li> </ul>	<ul style="list-style-type: none"> <li>Check the feedline and correct any improper condition.</li> <li>Check the antenna connector and clean the center conductor.</li> </ul>
<ul style="list-style-type: none"> <li>Your signal does not reach distances far away as usual.</li> </ul>	<ul style="list-style-type: none"> <li>The output power is set at "LOW".</li> <li>The antenna feedline is cut or shorted.</li> <li>The transceiver has selected Channel 15 or 17.</li> </ul>	<ul style="list-style-type: none"> <li>Check the "LOW" indicator on the display. If illuminated, push [HI/LO] switch to select HIGH output power.</li> <li>Check the feedline and correct any improper conditions.</li> <li>The transceiver transmits only LOW output power on Channels 15 and 17.</li> </ul>
<ul style="list-style-type: none"> <li>The displayed channel does not change.</li> </ul>	<ul style="list-style-type: none"> <li>The transceiver has selected Channel 16.</li> <li>The transceiver is set in HAILER or INTERCOM mode.</li> <li>No channel information has been programmed into memory channels.</li> <li>The transceiver is set in DUAL or TRI WATCH function.</li> </ul>	<ul style="list-style-type: none"> <li>Push [DIAL] switch then rotate the CHANNEL SELECTOR. (See pgs. 7, 8)</li> <li>Push [DIAL] switch then rotate the CHANNEL SELECTOR. (See pgs. 7, 8)</li> <li>Program memory channels. (See p. 12)</li> <li>Push [DUAL] or [TRI], or [DIAL] switch to cancel the function. (See pgs. 13, 14)</li> </ul>
<ul style="list-style-type: none"> <li>Programmed memory channels cannot be recalled.</li> </ul>	<ul style="list-style-type: none"> <li>Different channel groups may have been selected.</li> <li>The internal backup battery is exhausted.</li> </ul>	<ul style="list-style-type: none"> <li>Push [ABC] switch to select the same channel group you programmed. (See p. 12)</li> <li>Replace the battery with a new one at an authorized Icom Dealer or Icom Service Center.</li> </ul>
<ul style="list-style-type: none"> <li>The scan does not function.</li> </ul>	<ul style="list-style-type: none"> <li>Squelch is not set correctly.</li> <li>No channel information has been programmed into memory channels.</li> <li>The transceiver has selected Channel 16.</li> </ul>	<ul style="list-style-type: none"> <li>Push [UP] on [SQL] switch to set the squelch at the threshold point. (See p. 9)</li> <li>Program memory channels. (See p. 12)</li> <li>Push [DIAL] switch then push [SCAN] switch. (See pgs. 15, 16)</li> </ul>
<ul style="list-style-type: none"> <li>FUNCTION DISPLAY occasionally displays erroneous information.</li> </ul>	<ul style="list-style-type: none"> <li>The internal microprocessor has malfunctioned.</li> </ul>	<ul style="list-style-type: none"> <li>Turn power OFF then turn power ON again. If no solution is found, see Section 8-3 for resetting the microprocessor.</li> </ul>



## 8-2 FUSE REPLACEMENT

The IC-M500D and the UA-1 have 2 fuses installed on each DC power cable.

If the fuse blows or the transceiver stops functioning, track down the source of the problem if possible, and replace the damaged fuse with a new, rated fuse.

- Rated fuse : 10A

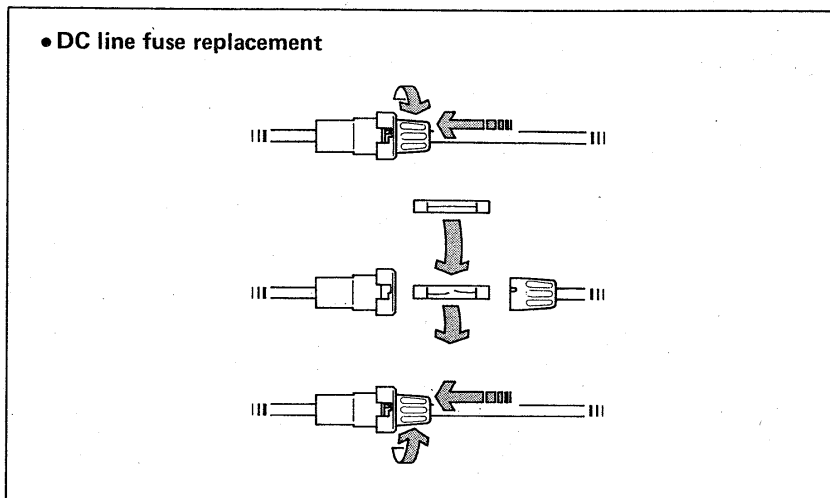

## 8-3 RESETTING THE MICROPROCESSOR

**NOTE:** After resetting the microprocessor, all information you have programmed into memory channels is erased.

**Reset the microprocessor under the following conditions:**

- The FUNCTION DISPLAY occasionally displays erroneous information during operation or when first applying power.
- You want to erase all information in all memory channels at one time.

**Reset as follows:**

- 1) Push and hold both the [DIM] and [13/67] switches, then push both [POW] switches to turn the power OFF.
- 2) Push and hold both the [DIM] and [13/67] switches again then push either [POW] switch to turn ON the power.
  - The FUNCTION DISPLAY illuminates all characters for a second.
  - The FUNCTION DISPLAY then illuminates Channel 16.

## 8-4 BACKUP BATTERY

The IC-M500D is equipped with a lithium backup battery. The usual life of the battery is more than five years. If the battery is exhausted, the transceiver operates normally but channel information in memory channels is not retained when the DC power cable is detached.

**NOTE:** Backup battery replacement MUST be done by an authorized Icom Dealer or Icom Service Center.

## 8-5 CLEANING

If the transceiver becomes dusty or dirty, wipe it clean with a dry, soft cloth.

**AVOID** the use of strong cleaning agents such as benzine or alcohol, as they may damage the transceiver surfaces.

# 9 VHF MARINE CHANNEL CHART

Channel No.	Frequency (MHz)		Transmitter output power
	Transmit	Receive	
01	156.050	160.650	25W & 1W
01A	156.050	156.050	25W & 1W
02	156.100	160.700	25W & 1W
02A	156.100	156.100	25W & 1W
03	156.150	160.750	25W & 1W
03A	156.150	156.150	25W & 1W
04	156.200	160.800	25W & 1W
04A	156.200	156.200	25W & 1W
05	156.250	160.850	25W & 1W
05A	156.250	156.250	25W & 1W
06	156.300	156.300	25W & 1W
07	156.350	160.950	25W & 1W
07A	156.350	156.350	25W & 1W
08	156.400	156.400	25W & 1W
09	156.450	156.450	25W & 1W
10	156.500	156.500	25W & 1W
11	156.550	156.550	25W & 1W
12	156.600	156.600	25W & 1W
13	156.650	156.650	25W & 1W
14	156.700	156.700	25W & 1W
*15	156.750	156.750	1W only
16	156.800	156.800	25W & 1W
17	156.850	156.850	1W only
18	156.900	161.500	25W & 1W
18A	156.900	156.900	25W & 1W
19	156.950	161.550	25W & 1W
19A	156.950	156.950	25W & 1W
20	157.000	161.600	25W & 1W
20A	157.000	157.000	25W & 1W
21	157.050	161.650	25W & 1W
21A	157.050	157.050	25W & 1W
22	157.100	161.700	25W & 1W
22A	157.100	157.100	25W & 1W
23	157.150	161.750	25W & 1W
23A	157.150	157.150	25W & 1W
24	157.200	161.800	25W & 1W
25	157.250	161.850	25W & 1W
26	157.300	161.900	25W & 1W
27	157.350	161.950	25W & 1W
28	157.400	162.000	25W & 1W
60	156.025	160.625	25W & 1W
60A	156.025	156.025	25W & 1W
61	156.075	160.675	25W & 1W
61A	156.075	156.075	25W & 1W
62	156.125	160.725	25W & 1W
62A	156.125	156.125	25W & 1W
63	156.175	160.775	25W & 1W
63A	156.175	156.175	25W & 1W
64	156.225	160.825	25W & 1W

\*Only receives on a U.S.A. channel

Channel No.	Frequency (MHz)		Transmitter output power
	Transmit	Receive	
64A	156.225	156.225	25W & 1W
65	156.275	160.875	25W & 1W
65A	156.275	156.275	25W & 1W
66	156.325	160.925	25W & 1W
66A	156.325	156.325	25W & 1W
67	156.375	156.375	25W & 1W
68	156.425	156.425	25W & 1W
69	156.475	156.475	25W & 1W
70	156.525	156.525	1W only
71	156.575	156.575	25W & 1W
72	156.625	156.625	25W & 1W
73	156.675	156.675	25W & 1W
74	156.725	156.725	25W & 1W
75	-----	-----	Guard
76	-----	-----	Guard
77	156.875	156.875	25W & 1W
78	156.925	161.525	25W & 1W
78A	156.925	156.925	25W & 1W
79	156.975	161.575	25W & 1W
79A	156.975	156.975	25W & 1W
80	157.025	161.625	25W & 1W
80A	157.025	157.025	25W & 1W
81	157.075	161.675	25W & 1W
81A	157.075	157.075	25W & 1W
82	157.125	161.725	25W & 1W
82A	157.125	157.125	25W & 1W
83	157.175	161.775	25W & 1W
83A	157.175	157.175	25W & 1W
84	157.225	161.825	25W & 1W
84A	157.225	157.225	25W & 1W
85	157.275	161.875	25W & 1W
85A	157.275	157.275	25W & 1W
86	157.325	161.925	25W & 1W
86A	157.325	157.325	25W & 1W
87	157.375	161.975	25W & 1W
87A	157.375	157.375	25W & 1W
88	157.425	162.025	25W & 1W
88A	157.425	157.425	25W & 1W
WX1	-----	162.550	RX only
WX2	-----	162.400	RX only
WX3	-----	162.475	RX only
WX4	-----	162.425	RX only
WX5	-----	162.450	RX only
WX6	-----	162.500	RX only
WX7	-----	162.525	RX only
WX8	-----	161.650	RX only
WX9	-----	161.775	RX only
WX10	-----	163.275	RX only

## ■ GENERAL

- Type of emission : 16K0G3E (16K0F3E)
- Antenna impedance : 50  $\Omega$
- Usable temperature range :  $-20^{\circ}\text{C} \sim +60^{\circ}\text{C}$  ( $-4^{\circ}\text{F} \sim +140^{\circ}\text{F}$ )
- Frequency stability :  $\pm 0.0005\%$
- Power supply voltage : 13.8 V DC (Floating ground)
- Dimensions : 287 mm (W) x 90 mm (H) x 208 mm (D)  
11.3" (W) x 3.5" (H) x 8.2" (D)  
Projections not included.
- Weight : 5.5 kg (12.1 lbs.)

## ■ RECEIVER

- Frequency range : 156 ~ 163 MHz
- Sensitivity : 0.35  $\mu\text{V}$  for 12 dB SINAD
- Audio output power : 10 W at 10% distortion with a 4  $\Omega$  load
- Intermediate frequencies : 1st 21.8 MHz 2nd 455 kHz
- Current drain : Approx. 0.7 A (standby condition)  
Approx. 2.7 A at max. audio output

## ■ TRANSMITTER

- Frequency range : 156 ~ 157.5 MHz
- Output power : HIGH 25 W LOW 1 W
- Microphone impedance : 600  $\Omega$
- Current drain : Approx. 9.0 A at HIGH output power  
Approx. 2.5 A at LOW output power

## IMPORTANT EMERGENCY INFORMATION

- If your vessel requires assistance, contact other vessels and the Coast Guard by sending a distress call on Channel 16.

### ■ DISTRESS CALL PROCEDURE:

1. "MAYDAY MAYDAY MAYDAY"
2. "THIS IS " ..... (name of vessel)
3. "LOCATED AT " ..... (vessel's position)
4. Give the reason for the distress call.
5. Explain what assistance you need.
6. Give additional information:
  - vessel type
  - vessel length
  - vessel color

## OPTIONS

### ■ EM-48 HAND MICROPHONE

The EM-48 is designed for use with marine transceivers and is a splash resistant-type hand microphone. The microphone can be connected to the UA-1 when operating the UA-1 without the IC-M500D.

### ■ OPC-198 INTERCOM CABLE

Required for INTERCOM operation with the IC-M500D.

- Length : 15 m (50 ft)
- Connectors : Matched with IC-M500D and UA-1 AUDIO AMPLIFIER

### ■ PS-66 DC-DC CONVERTER

Required for operation with a 24 V battery.

- Input voltage : 19 ~ 32 V DC
- Output voltage : 13.6 V DC
- Max. current capacity : 30 A

Count on us!

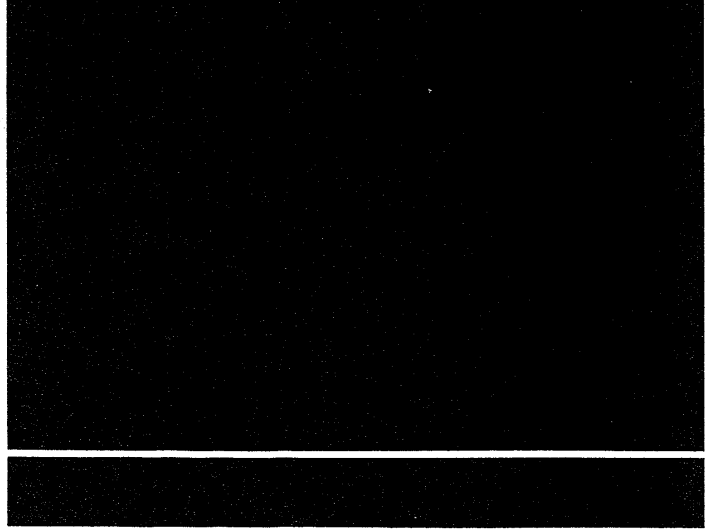

---

---

---

---

---

---

---

---